

Caution : One power supply
can only drive 3pcs LED light strip most

4500/4850/5000X1500(1000+500)
 4500/4850/5000X2000(1000+1000)
 4500/4850/5000X2250(1250+1000)
 4500/4850/5000X2500(1250+1250)

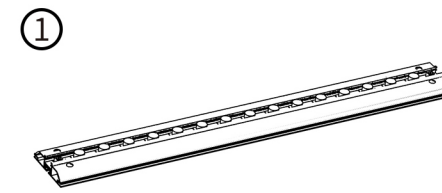

Horizontal Profile x 10

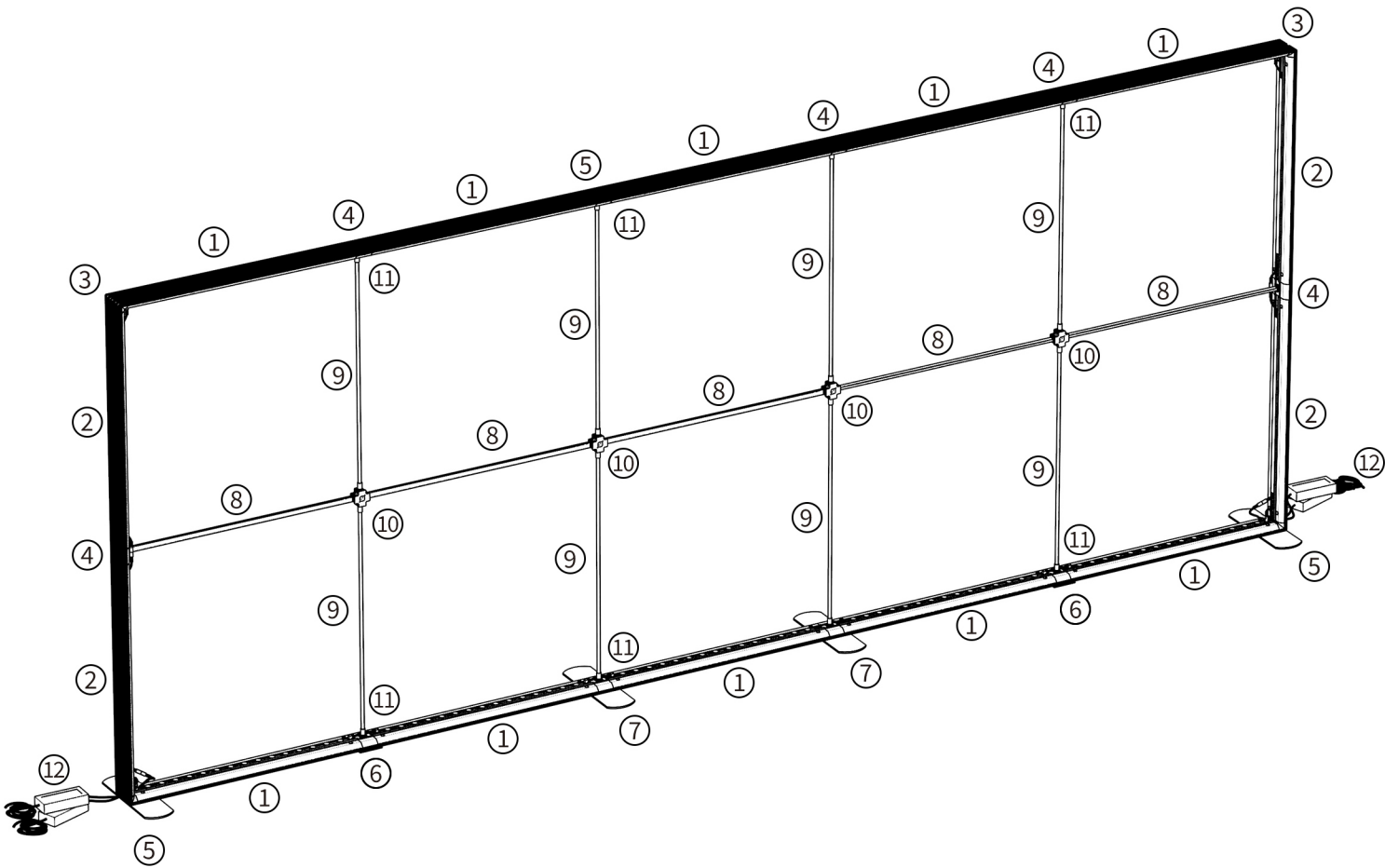
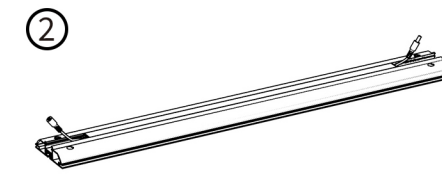

Extrusion for female & male connecting wire x 4

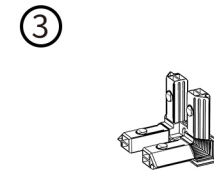

Corner Part x 2

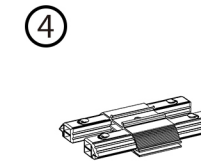

Connector Part x 6

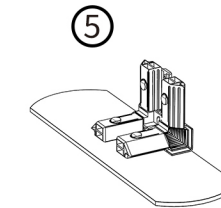

Base Foot x 2

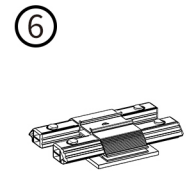

Base Foot x 2
Using For Big Size

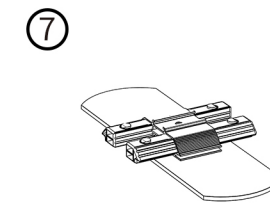

Base Foot x 2
Using For Big Size

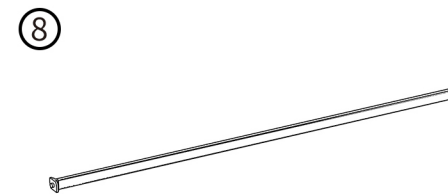

Support Pole x 5

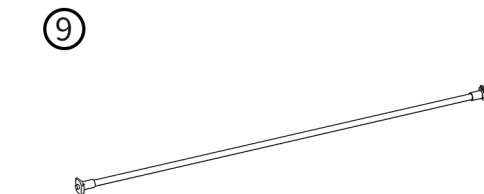

Round Shape Support Pole x 8

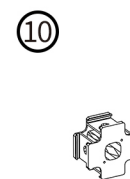

Cross Part x 4

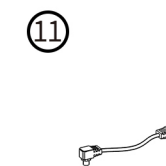

Double Male Connecting Wire x 6

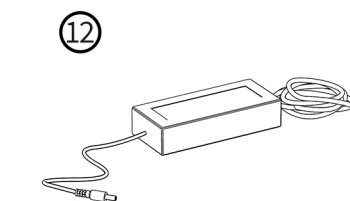

Power Supply x 4

1

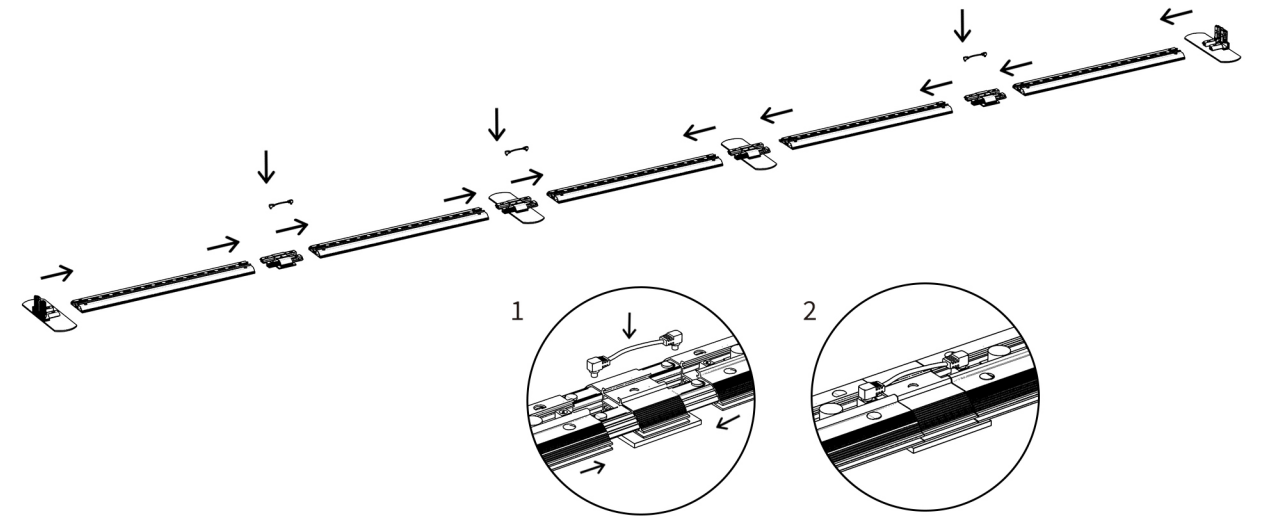

2

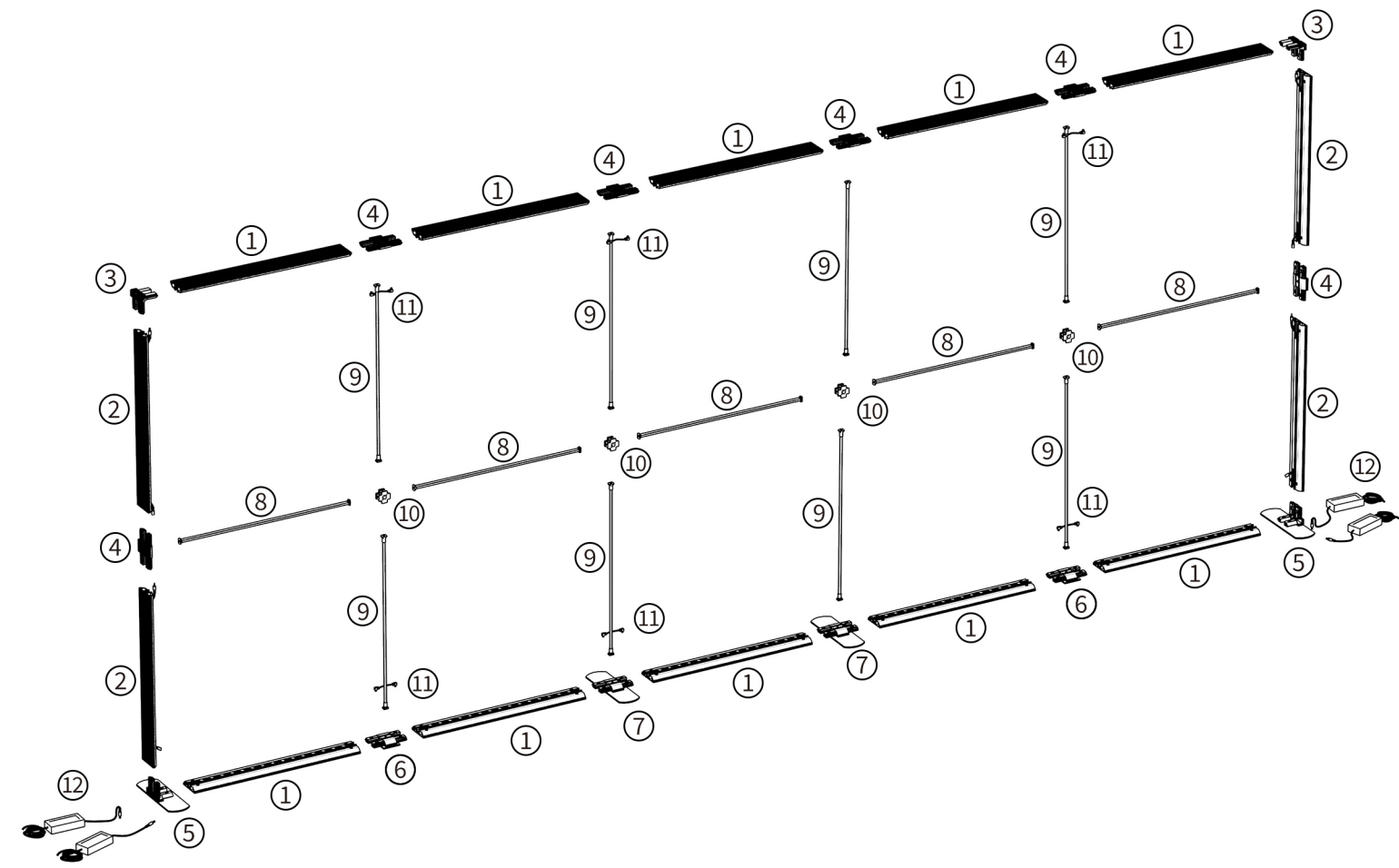
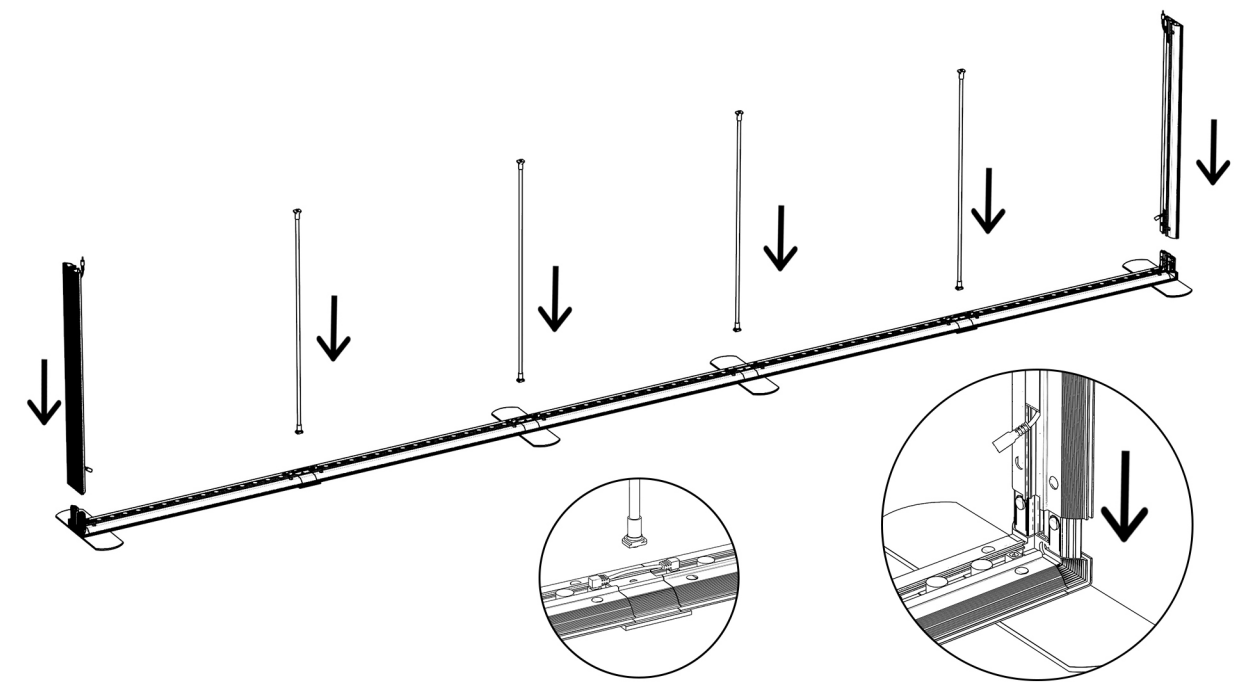

43

44

3

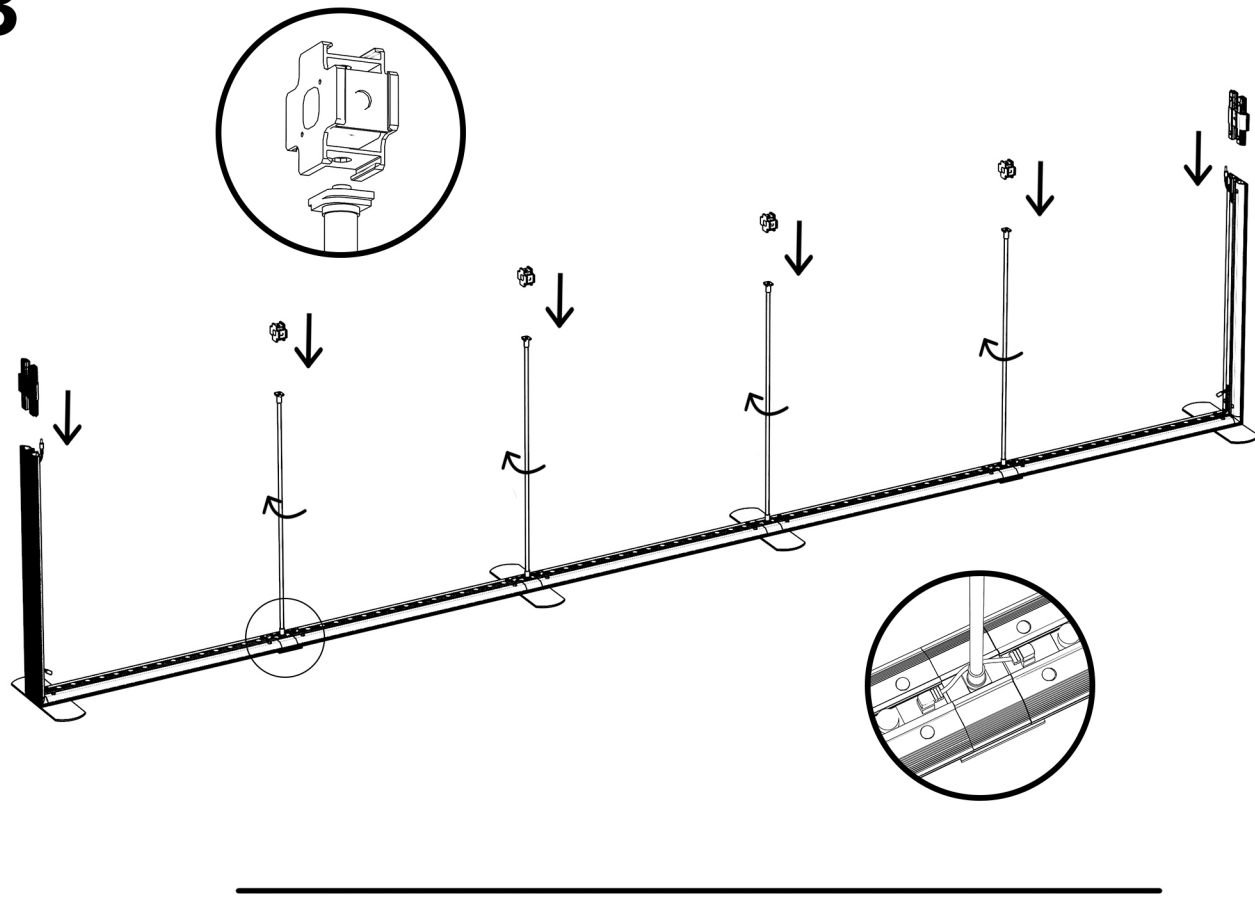

5

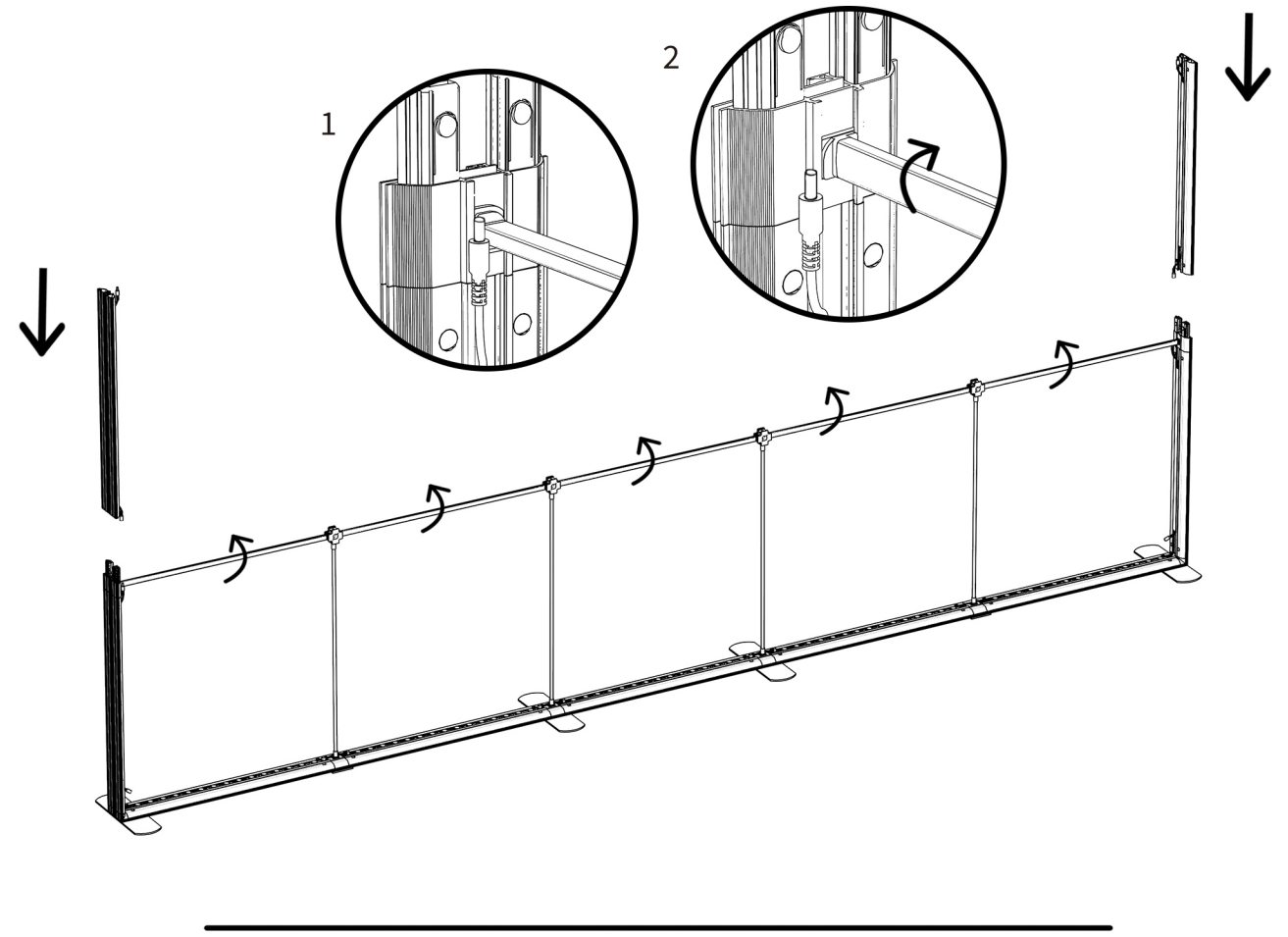

4

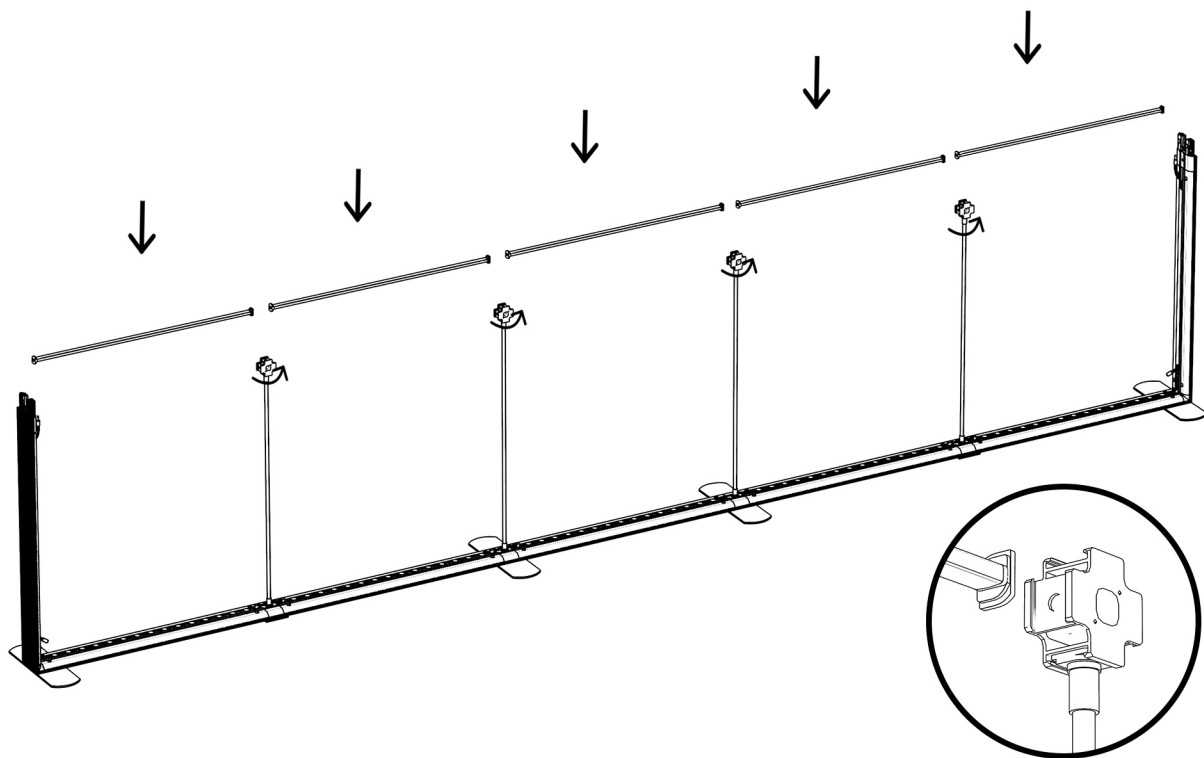

6

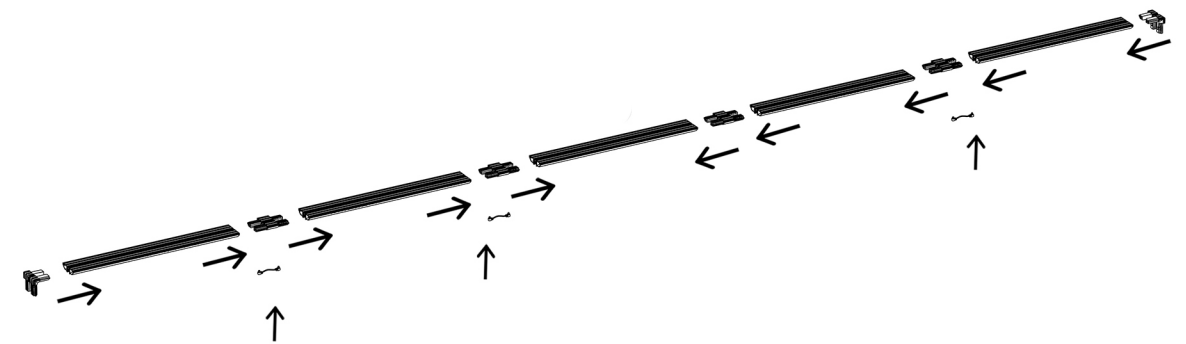

45

46

7

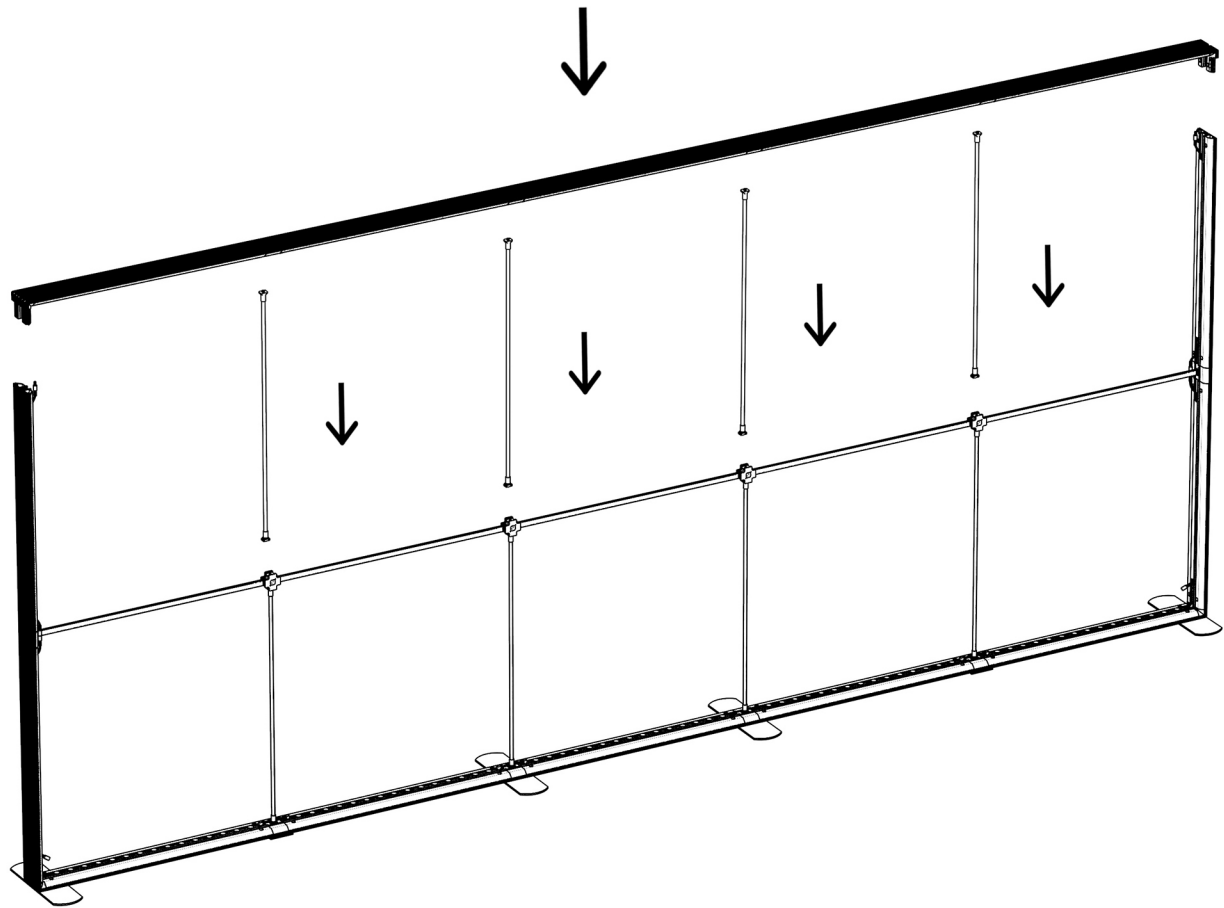

8

